

Phase Diagrams in Chemical Engineering: Application to Distillation and Solvent Extraction

Christophe Coquelet, Deresh Ramjugernath

► To cite this version:

Christophe Coquelet, Deresh Ramjugernath. Phase Diagrams in Chemical Engineering: Application to Distillation and Solvent Extraction. Zeeshan Nawaz and Shahid Naveed. Advances in Chemical Engineering, Intech, 23 p., 2012, 978-953-51-0392-9. 10.5772/33632 . hal-00877007

HAL Id: hal-00877007

<https://hal-mines-paristech.archives-ouvertes.fr/hal-00877007>

Submitted on 25 Oct 2013

HAL is a multi-disciplinary open access archive for the deposit and dissemination of scientific research documents, whether they are published or not. The documents may come from teaching and research institutions in France or abroad, or from public or private research centers.

L'archive ouverte pluridisciplinaire **HAL**, est destinée au dépôt et à la diffusion de documents scientifiques de niveau recherche, publiés ou non, émanant des établissements d'enseignement et de recherche français ou étrangers, des laboratoires publics ou privés.

Phase Diagrams in Chemical Engineering: Application to Distillation and Solvent Extraction

Christophe Coquelet^{1,2} and Deresh Ramjugernath¹

*¹Thermodynamic Research Unit,
School of Chemical Engineering,
University KwaZulu Natal,
Howard College Campus, Durban*

*²MINES ParisTech,
CEP/TEP - Centre Énergétique et Procédés, Fontainebleau*

¹South Africa

²France

1. Introduction

By definition, a phase diagram in physical chemistry and chemical engineering is a graphical representation showing distinct phases which are in thermodynamic equilibrium. Since these equilibrium relationships are dependent on the pressure, temperature, and composition of the system, a phase diagram provides a graphical visualization of the effects of these system variables on the equilibrium behavior between the phases. Phase diagrams are essential in the understanding and development of separation processes, especially in the choice and design of separation unit operations, e.g. knowledge about high pressure phase equilibria is essential not just in chemical processes and separation operations, but is also important for the simulation of petroleum reservoirs, the transportation of petroleum fluids, as well as in the refrigeration industry. In order to utilize the knowledge of phase behavior it is important to represent or correlate the phase information via the most accurate thermodynamic models. Thermodynamic models enable a mathematical representation of the phase diagram which ensures comprehensive and reproducible production of phase diagrams. The measurement of phase equilibrium data is necessary to develop and refine thermodynamic models, as well as to adjust them by fitting or correlating their parameters to experimental data. Generally the measurement of phase equilibria is undertaken using two categories of experimental techniques, viz. synthetic and analytic methods. The choice of the technique depends on the type of data to be determined, the range of temperatures and pressures, the precision required, and also the order of magnitude of the phase concentrations expected.

2. Definition of phases, phase transitions, and equilibrium

A phase is a homogeneous space, which can be composed of one or more components or chemical species, in which the thermodynamic properties, e.g. density or composition, are

identical. A system can comprise of one or several phases. Depending on whether one or more phases exist, the system can be defined as a monophasic homogenous system in which the composition and thermodynamic properties are identical in the whole space, or as a multiphase heterogenous system for which thermodynamic properties change distinctly at the phase interface. A phase is characterized by its temperature, density, pressure, and other thermodynamics properties, i.e. Gibbs energy, molar enthalpy, entropy, heat capacity, etc.

The concept of a phase can be employed to distinguish between the different states of matter. Matter is generally accepted to exist in three main states, viz. gas, liquid, and solid. Other types of phases do exist, e.g. nematic and smectic phase transitions in liquid crystal, but this will not be relevant to this chapter. Molecular interactions between the components or chemical species which comprise the system are responsible for the different states of matter. Consequently thermodynamics model used to describe phases have to take into account the molecular interactions, or be used at conditions at which they are relevant, e.g. the ideal gas model can only be applied to gas phase at low pressures and sufficiently high temperatures, as at these conditions molecular interactions are negligible.

2.1 Phases transitions

There a number of definitions that can be used to describe a liquid. One of the definitions, which is easy to visualize but may not be entirely thermodynamically correct, is that a liquid is a fluid which takes the form of its containment without necessarily filling the entire containment volume. This characteristic distinguishes a liquid from a solid, as well as a liquid from a gas. As stated, it is not an accurate definition and it is necessary to carefully check the thermophysical microscopic (structure) and macroscopic properties of the state of matter.

A phase change is the transition between different states of matter. It is generally characterized by a sudden change of the internal microscopic structure and the macroscopic properties of the environment. It is probably better to refer to it as a phase transition instead of phase change because a phase transition doesn't imply the change of state of the matter, e.g. liquid-liquid or solid-solid phase transitions. For a solid-solid phase transition there can be a change of the structure of the crystal.

A phase transition can be effected by a change of the composition, temperatures and/or pressures of the system, or by application of an external force on the system. Consequently, composition, density, molar internal energy, enthalpy, entropy, refractive index, and dielectric constant have different values in each phase. However, temperature and pressure are identical for all phases in multiphase systems in compliance with thermodynamic principles. As a result, when two phases (or more) exist, we refer to it as phase equilibria. Table 1 lists all the phase transitions between solid, liquid and vapor phases.

Phase 1	Phase 2	Transition 1-2
liquid	vapor	boiling
liquid	solid	solidification
vapor	liquid	liquefaction
vapor	solid	condensation
solid	vapor	sublimation
solid	liquid	melting

Table 1. Phases transitions.

There are two types of phase transition:

First order: In this type of transition there is a discontinuity in the first derivative of the Gibbs free energy with regard to thermodynamic variables. For this type of transition there is an absorption or release of a fixed amount of energy with the temperature remaining constant.

Second order: For this type of transition, there is continuity in the first derivative of the Gibbs free energy with regard to the thermodynamic variable across the transition, but there is a discontinuity in the second derivative of the Gibbs energy with regard to thermodynamic properties.

2.2 Chemical potentials and equilibrium conditions

2.2.1 Chemical potential

The chemical potential is the one of the most important thermodynamic properties used in the description of phase equilibrium. If one considers a phase with volume V , containing n_c components at temperature T and pressure P , the chemical potential μ_i of component i in the phase is defined by

$$\mu_i(P, T, n_1, n_2, \dots, n_c) = \left(\frac{\partial G(P, T, n_1, n_2, \dots, n_c)}{\partial n_i} \right)_{T, P, n_{j \neq i}} \quad (1)$$

Where $G=H-TS$ is the Gibbs free energy of the phase. The expression for the infinitesimal reversible change in the Gibbs free energy is given by

$$dG = VdP - SdT + \sum_i \mu_i dn_i \quad (2)$$

Moreover, from Euler theorem we can write $G = \sum_{i=1}^{N_c} n_i \mu_i$. The Gibbs-Duhem (Eq. 3) equation can be obtained from equations 1 and 2:

$$VdP - SdT + \sum_i n_i d\mu_i = 0 \quad (3)$$

2.2.2 Equilibrium conditions

Considering a multicomponent system in equilibrium between two phases (α and β), at temperature T and pressure P , the Gibbs free energy of this system is $G=G^\alpha+G^\beta$, where G^α and G^β , are the Gibbs free energy of the α and β phases respectively. At equilibrium, the Gibbs free energy must be at the minimum, therefore ($dG=0$):

$$dG = dG^\alpha + dG^\beta = \sum_i \mu_i^\alpha dn_i^\alpha + \sum_i \mu_i^\beta dn_i^\beta = 0 \quad (4)$$

For a closed system, $dn_i^\beta = -dn_i^\alpha$ for each component i between phases α and β . For each chemical species, the following relationship can be written:

$$\mu_i^\alpha(P, T, n_1^\alpha, n_2^\alpha, \dots, n_{N_c}^\alpha) = \mu_i^\beta(P, T, n_1^\beta, n_2^\beta, \dots, n_{N_c}^\beta) \quad (5)$$

Consequently, the equilibrium condition of a multiphase mixture is equality of temperature, pressure, and chemical potential μ_i of each component i in all the phases in equilibrium.

3. Description of phase diagrams

3.1 Pure compound

3.1.1 Description

The phase diagram of a pure compound is characterized by its critical point, triple point, vapor pressure, and melting and sublimation curves (figure 1). At the triple point, the solid, liquid, and vapor phases coexist. The critical point can be defined as the upper limit for the pure component vapor pressure curve. For temperatures and pressures above the critical conditions, there is no possibility to have vapor-liquid equilibrium. The supercritical state can be considered as a "stable state" with no possibility for phase separation.

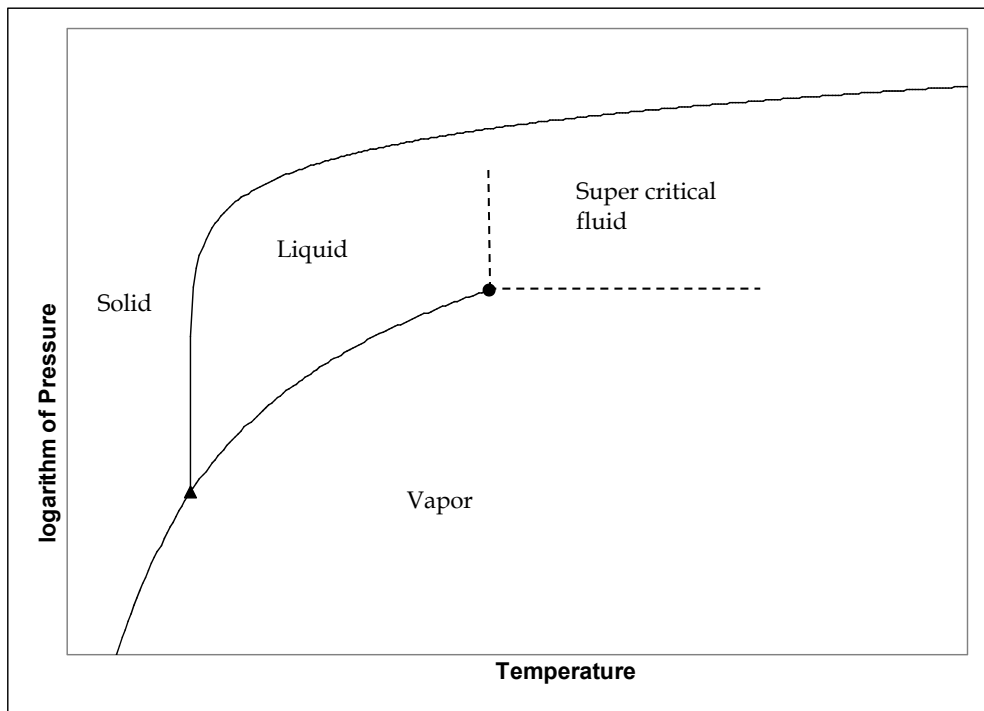

Fig. 1. Pure compound Pressure-Temperature phase diagram. (▲) Triple point, (●) : critical point. Lines : Coexistence curves

The number of intensive variables which have to be specified in order to characterize the system is determined with the Gibbs phases rule (Eq. 6).

$$F = C + 2 - \phi \quad (6)$$

Were, F , is the of degrees of freedom, C , is the number of components and Φ , is the number of phases present. Table 2 illustrates the degrees of freedom for a single component system.

Region of the phase diagram	Number of phases	Degrees of freedom	Variables to be specified
vapor pressure, or melting or sublimation curves	2	1	T or P
liquid, vapor, or solid	1	2	P and T
Triple point	3	0	Everything is fixed
Critical point	2	1	T_C or P_C

Table 2. Degrees of freedom for a pure component ($C=1$)

The phase behavior of a pure component can be represented in a plot of pressure versus temperature. Assuming that there are only two co-existing phases, i.e. a liquid and vapor phase, the vapor-liquid equilibrium can be represented as shown in Figure 2.

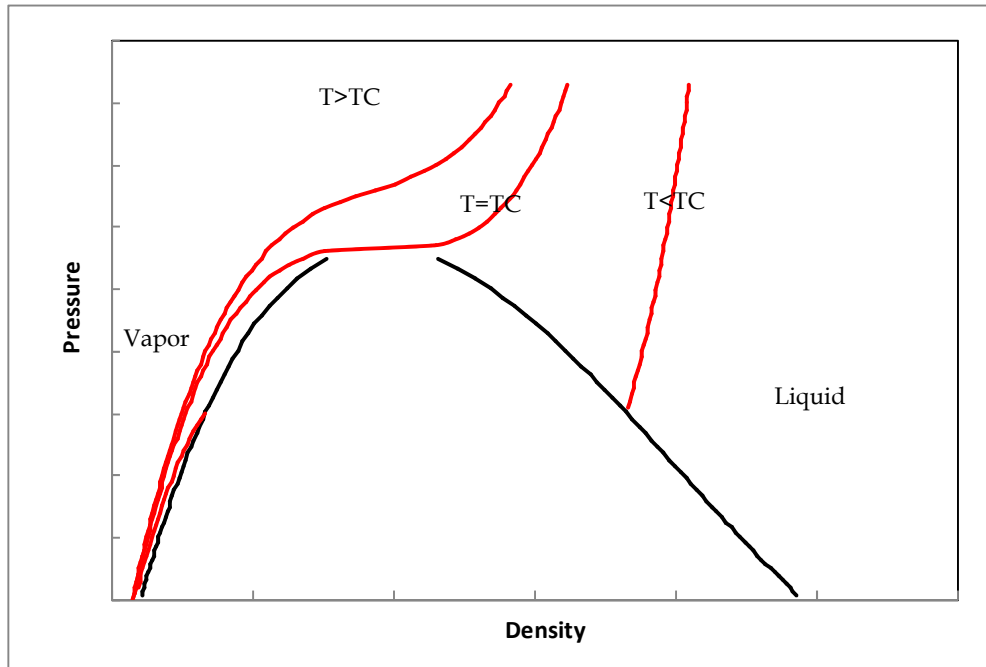

Fig. 2. Pure compound Pressure-Temperature-density phase diagram. Red line: isothermal curve. Black line saturation curve (bubble and dew points lines)

3.1.2 The critical point

The critical point of a pure compound is the upper limit (temperature and pressure) of the pure component vapor pressure curve. For temperatures and pressures below the critical

point, phase separation can occur leading to two phases in equilibrium (liquid and vapour). The critical point can be considered as a limit of stability of the supercritical phase.

Critical properties (T_C , P_C , ...) characterize the critical point and the value of the properties are particularly influenced by molecular interactions, i.e. if there are strong attractive interaction between the molecules, the value of the critical temperatures and pressures are greatly increased. Using the example of water [NIST, 2010 #167] ($T_C= 647.13$ K, $P_C= 22.055$ MPa) one can clearly observe that the values of the critical properties are far greater when compared to those of methane [NIST, 2010 #167] ($T_C= 190.564$ K, $P_C= 4.599$ MPa). Hydrogen bonding between molecules of water is responsible for association effects between water molecules.

At the critical point, due to the fluctuation of the density, there is a disturbance of light waves across the visual spectrum. This phenomenon is called critical opalescence. At the critical point there is a second order type phase transition. In the Pressure-density diagram (figure 2), the isotherm labeled T_C has an inflection point and is characterized by the following relations:

$$P > 0, \left(\frac{\partial P}{\partial v} \right)_T = 0, \left(\frac{\partial^2 P}{\partial v^2} \right)_T = 0, \left(\frac{\partial^3 P}{\partial v^3} \right)_T < 0 \quad (7)$$

Experimentally, it can be observed that along the coexisting curve liquid and vapor densities diverge at the critical point following the relationship $\rho_L - \rho_V \propto (T_C - T)^\beta$ where ρ_C and T_C are the critical density and critical temperature respectively and β is an universal critical exponent (value is around 0.326, whatever the pure compound). This mathematical relationship is one of thermodynamics relationships and referred to as scaling laws. For pressure, one can write the following relationship along the critical isotherm curve:

$\left| \frac{P - P_C}{P_C} \right| \propto \left| \frac{\rho - \rho_C}{\rho_C} \right|^\delta$, where $\delta = 4.800$. With regard to heat capacity, the following equation

can be written along the critical isochor: $C_V \propto k_{\alpha 0} + k_{\alpha 1} (\Delta\tau)^{-\alpha}$ for $\rho = \rho_C$ with $\Delta\tau = \left| \frac{T - T_C}{T_C} \right|$.

For isothermal compressibility the relationship along the critical isochors is $\chi \propto k_{\alpha 1} (\Delta\tau)^{-\gamma}$

for $\rho = \rho_C$ with $\Delta\tau = \left| \frac{T - T_C}{T_C} \right|$. The exponents' δ , α and γ are also referred to as critical

exponents. Simple relationships can be written between these exponents, e.g. $\alpha + 2\beta + \gamma = 2$. All of these laws are also observed experimentally and can be derived from renormalisation theory. Table 3 shows the optimum values for these critical exponents.

Critical exponent	Values
α	0.110
β	0.3255
γ	1.239
δ	4.800

Table 3. Critical exponents

3.1.3 Triple point

At the triple point, the three states of the matter (solid, liquid, and vapor) are in equilibrium. The temperature and pressure of the triple point is fixed because the degrees of freedom at this point is equal to zero. Triple point values are very useful for the definition of reference points on temperature scales and for the calibration of experimental equipment. The table 4 lists triple point conditions for some for some common chemicals.

Compound	T_{tr}/K	P_{tr}/kPa
Water	273.16	0.6117
Ethanol	150	4.3×10^{-7}
Oxygen	54.36	0.152
Methane	90.67	11.69

Table 4. Triple points of few pure compounds (Ref. : NIST [NIST, 2010 #167]).

3.2 Binary systems

The first equation of state, which could describe the behaviour of both liquid and vapour states of a pure component, was developed by (van der Waals, 1873). Two types of interactions (repulsive and attractive) were considered in this equation.

$$\left(P + \frac{a}{v^2}\right)(v - b) = RT \quad (8)$$

The stability criteria are defined by the following equations:

$$\left(\frac{\partial P}{\partial v}\right)_T < 0, \left(\frac{\partial^2 P}{\partial v^2}\right)_T < 0 \text{ and } \frac{T}{c_v} > 0$$

At the critical point these two previous conditions are equal to zero.

$$\left(\frac{\partial P}{\partial v}\right)_T = 0, \left(\frac{\partial^2 P}{\partial v^2}\right)_T = 0 \text{ and } \frac{T}{c_v} = 0$$

It can be seen that at the critical point, the isochoric heat capacity has infinite value. Phase diagram describing binary mixtures depend of the behaviour of the species. Van Konynenburg & Scott (1980) have classified the phase behaviour of binary mixtures into six types considering van der Waals EoS and quadratic mixing rules. Figure 3 presents the different types of phase diagrams. The transition between each type of phase diagram can be explained by considering the size effects of molecules and the repulsive interactions between them. Figure 4 illustrates the possible transitions between the different types of phase diagrams.

3.2.1 Mixture critical point

The thermodynamic stability of a mixture determines if it would remain as a stable homogenous fluid or split into more stable phases and therefore produce two or more

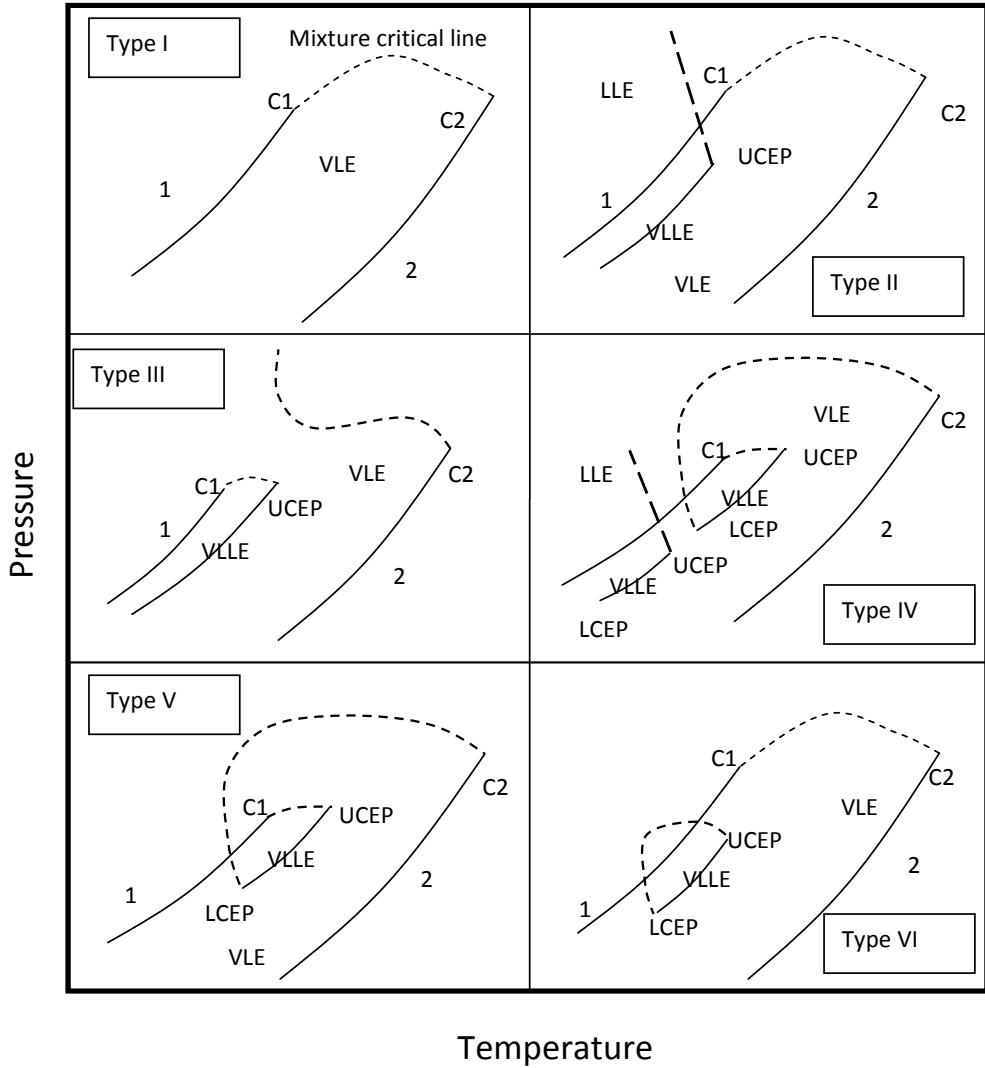

Fig. 3. Six types of phase behaviour in binary fluid systems. C: Critical point, L: Liquid, V: Vapor. UCEP: Upper critical end point, LCEP: Lower critical end point. Dashed curve are critical.

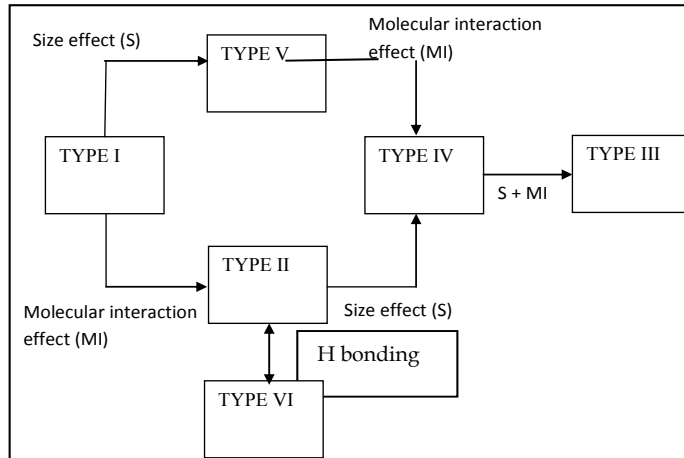
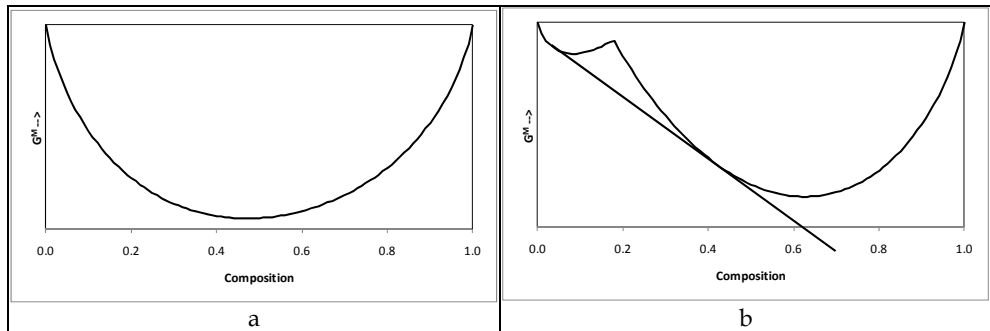

Fig. 4. Evolution of phase diagrams.

phases in equilibrium. By definition, a mixture is considered as stable when the Gibbs or Helmholtz free energy are at their minimum. Figure 5 gives an indication of the change of the Gibbs free energy with composition for a given temperature and pressure from stable condition (a) (T, P) to an unstable condition (b). In figure 5 b, one can observe that there are



a): stable condition, b): unstable condition with phase equilibria.

Fig. 5. Mixing Gibbs free energy (G) as a function of molar composition (x_1) at given T and P .

two minima: this corresponds to phase equilibria. More details on thermodynamic phase stability are given by (Michelsen, 1982a). A Taylor series expansion can be obtained for the Gibbs free energy for a given temperature:

$$\begin{aligned}
 G = & \sum_i n_i^0 \mu_i^0 + \sum_i \mu_i^0 \Delta n_i + \frac{1}{2} \sum_i \sum_j \left(\frac{\partial^2 G}{\partial n_i \partial n_j} \right)_{T,P} \Delta n_i \Delta n_j + \\
 & \frac{1}{6} \sum_i \sum_j \sum_k \left(\frac{\partial^3 G}{\partial n_i \partial n_j \partial n_k} \right)_{T,P} \Delta n_i \Delta n_j \Delta n_k + \Theta(\Delta n^5)
 \end{aligned}
 \tag{9}$$

With $n_i = n_i^0 + \Delta n_i$ and $V = V^0 + \Delta V$.

The stability condition leads to:

$$G - \sum_i n_i^0 \mu_i^0 - \sum_i \mu_i^0 \Delta n_i \geq 0 \quad (10)$$

Consequently

$$\frac{1}{2} \sum_i \sum_j \left(\frac{\partial^2 G}{\partial n_i \partial n_j} \right)_{T,P} \Delta n_i \Delta n_j + \frac{1}{6} \sum_i \sum_j \sum_k \left(\frac{\partial^3 G}{\partial n_i \partial n_j \partial n_k} \right)_{T,P} \Delta n_i \Delta n_j \Delta n_k + \Theta(\Delta n^5) \geq 0 \quad (11)$$

The critical point can be described as the limit of stability (x is the molar fraction) and coordinates (P , v) can be determined considering the following relations. More details are given by (Michelsen, 1980, 1982b), (Heidmann & Khalil, 1998) and (Stockfleth & Dohrn, 1980).

$$G_{2x} = \left(\frac{\partial^2 G}{\partial n_i \partial n_j} \right)_{T,P} = 0 ; G_{3x} = \left(\frac{\partial^3 G}{\partial n_i \partial n_j \partial n_k} \right)_{T,P} = 0 ; G_{4x} = \left(\frac{\partial^4 G}{\partial n_i \partial n_j \partial n_k \partial n_l} \right)_{T,P} > 0 \quad (11)$$

In their paper, (Baker et al., 1982) present several examples of Gibbs energy analysis. Figure 6 compares phase diagrams (pressure/composition) and the Mixing Gibbs free energy at a given temperature.

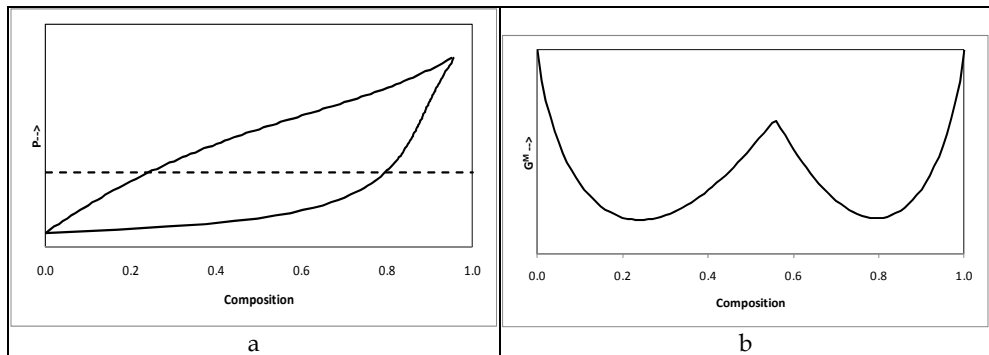

A) Phase diagram at a given temperature. Dashed line: given pressure. B) Gibbs free energy of mixing at the same temperature and given pressure.

Fig. 6. Example of Mixing Gibbs free energy minimum for a binary system.

3.2.2 Phase diagram classification

Type I phase behaviour

It is the simplest type of phase diagram. The mixture critical point line starts at the first pure component critical point and finish at the second pure component critical point. Mixtures which exhibit this behaviour are two components which are chemically similar or have comparable critical properties., e.g. systems with CO₂ and light hydrocarbons, systems with HFC refrigerants, and benzene + toluene binary systems.

Type II phase behaviour

It is similar to type I but at low temperatures, the two components are not miscible in the liquid mixtures. Consequently a liquid - liquid equilibrium appears. The mixture critical point line for liquid - liquid equilibrium starts from the UCEP (upper critical end point). At the UCEP, the two liquid phases merge into one liquid phase. Examples of systems which exhibit this behaviour are those with hydrocarbons and fluorinated fluorocarbons.

Type III phase behaviour

Generally system which have very large immiscibility gaps exhibit this behaviour, e.g. aqueous systems with hydrocarbons. A liquid - liquid - vapour curve appears and a first mixture critical point line starts from the pure component 1 critical point and ends at the UCEP. The second one starts from the infinite pressure ($P \rightarrow \infty$) and ends at the pure component 2 critical point, generally the solvent i.e. water. The slope of this second curve can be positive, negative or positive and negative. Concerning the positive curve, we have two phases at temperatures larger than the critical temperature of pure component two.

Some examples:

Positive slope: helium + water binary system

Negative slope: methane + toluene binary system

Positive and negative slope: nitrogen + ammonia or ethane + methanol binary systems.

Type IV phase behaviour

It is similar to type V behaviour. The vapor-liquid critical point line starts at the critical point of component 2 and ends at the LCEP (lower critical end point). Vapour-liquid-liquid equilibrium (VLLE) exists and is present in two parts. Ethane + n-propanol and CO_2 + nitrobenzene binary systems are examples of systems which show this behaviour.

Type V phase behaviour

It is a modification of type III phase diagram. There are two vapor-liquid critical point lines. One goes from the pure component critical point 1 and ends at the UCEP. The other starts at the pure component critical point 2 and ends at the LCEP. Contrary to type IV systems, below the LCEP the liquids are completely miscible. The ethylene + methanol binary system is an example of a type V system.

Type VI phase behaviour

There are two critical point curves. The first is similar to one presented with the type II diagram: a connection between the two pure component critical points. The second connects the LCEP and the UCEP. Between these two points, there exists VLLE. The system "water + 2-butanol" is a typical example of a type VI system. In fact the main reason is due to the existence of hydrogen bonding for one or both of the pure components (self association) and in the mixture (strong H bonding between the two components). H bonding favours the heat of solution and so miscibility in the liquid state. Above the LCEP hydrogen bonds break and the liquid becomes unstable and a second liquid phase appears.

3.3 Ternary systems

There exists a number of different classifications for ternary systems, but we propose that of Weinstock (1952). According to this classification the system can exhibit vapor-liquid, liquid-liquid, and also vapor-liquid-liquid equilibrium (VLE, LLE and VLLE). Considering vapor-liquid-liquid equilibria, the phase diagrams can be classified into 3 categories or types. For ternary diagrams, in general, temperature and pressure are fixed.

Type 1 :

It is the most common diagram. In figure 7, one can observe VLE and the monophasic regions. The shape of the phase diagram changes with the pressure. In figure 8, one can see the phase diagram for the ternary system comprising R32 + R227ea + R290 (Coquelet et al., 2004).

Type 2 :

It is an evolution of a type 1 phase diagram: VLLE and LLE appear but the two liquids are partially miscible (see figure 9).

Type 3 :

According to figure 10, there exists strong immiscibility between two species. The size of the LLE region increases with pressure. Consequently, LLE region disappears to form a Liquid Fluid Equilibrium region (if there is a supercritical fluid).

There is also classification for Liquid - liquid equilibrium phase diagram. There are generally three distinguishable categories (Figure 11) :

- One pair of binary components are partially miscible (type 1)
- Two pairs of binary components are partially miscible (type 2)
- All three pairs of binary components are partially miscible (type 3)

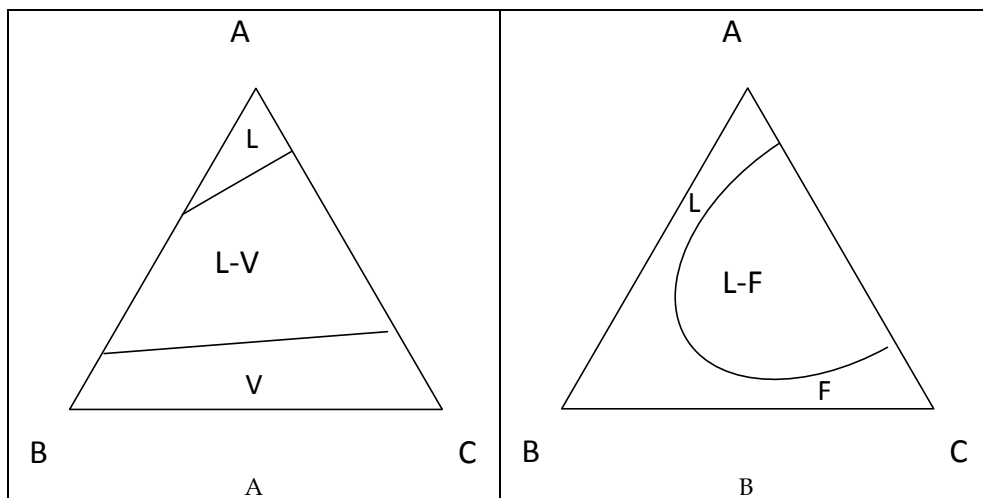

A: Vapor-Liquid Equilibria (VLE), B: if T or P is increased a supercritical fluid (F) appears and so a FLE.

Fig. 7. Ternary diagram: type 1.

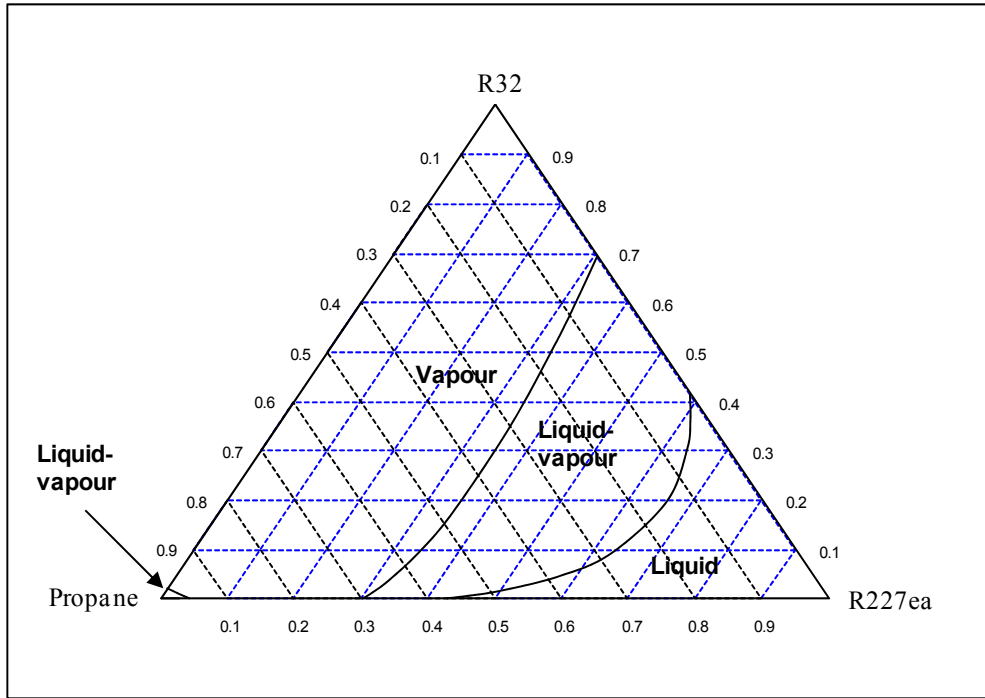

Fig. 8. Phase diagram of the ternary system R32-R290-R227ea at $T=293\text{ K}$ and $P=8.5\text{ bar}$ (Coquelet et al., 2004).

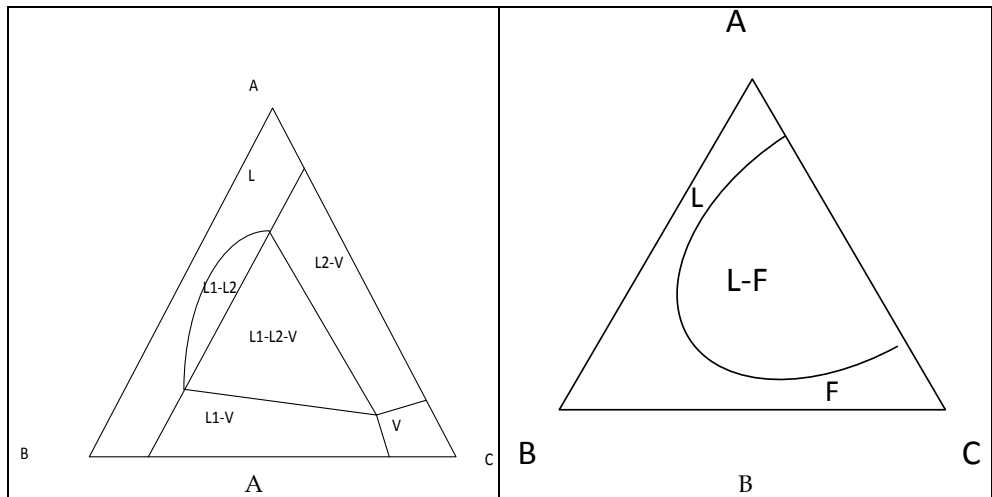

Fig. 9. Ternary diagram: type 2. A: Existence of Vapor Liquid Liquid Equilibrium, B: if we increase pressure or temperature, we have a supercritical fluid in equilibrium with one liquid phase (FLE).

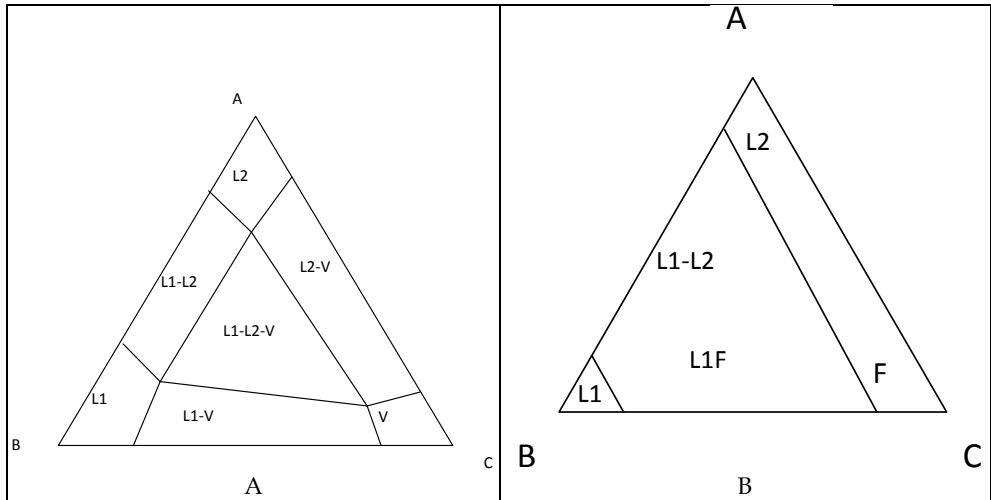

Fig. 10. Ternary diagram: type 3. A: There exists Liquid-Liquid Equilibria (L1L2E) between species A and B: if we increase pressure or temperature, we have a supercritical fluid in equilibrium with one liquid phase (FLE) and L1L2E.

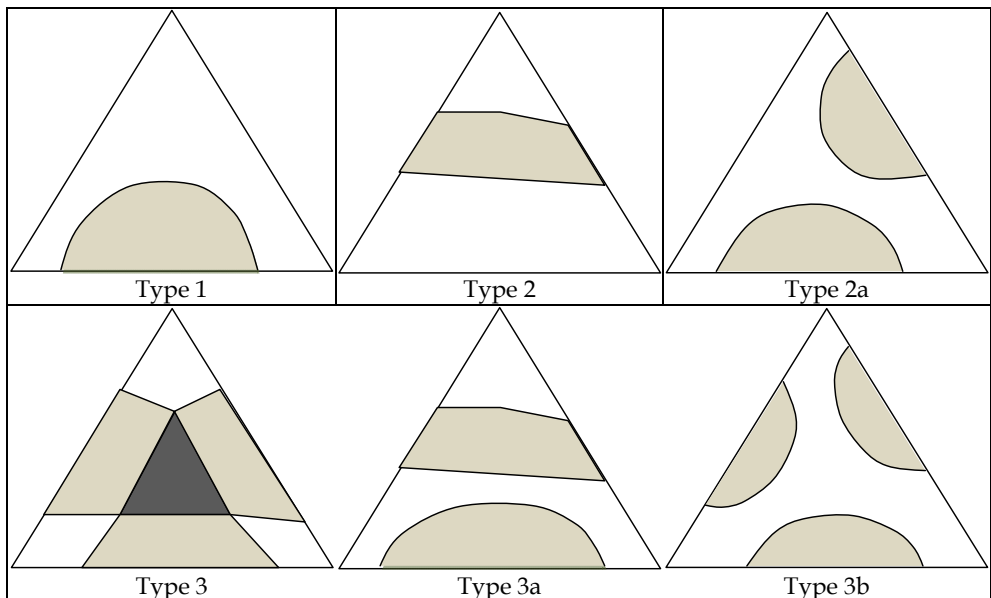

Fig. 11. Liquid - liquid equilibrium : presentation of the 3 configurations of the type 1, 2 and 3 systems.

3.4 Pressure-temperature envelops

The Pressure-Temperature (P-T) envelop is a very interesting way to represent phase diagrams. For a mixture (where composition is known), the P-T envelop represents the limits of the phase equilibrium region. An example of a P-T envelop is illustrated in figure 12. The point which corresponds to the maximum of pressure is called the cricondenbar, and with regard to the maximum of temperature, it is called the cricondentherm. Bubble and dew pressures curves are also presented in such a diagram with the critical point. With such a diagram, phenomenon such as retrograde condensation can be easily explained.

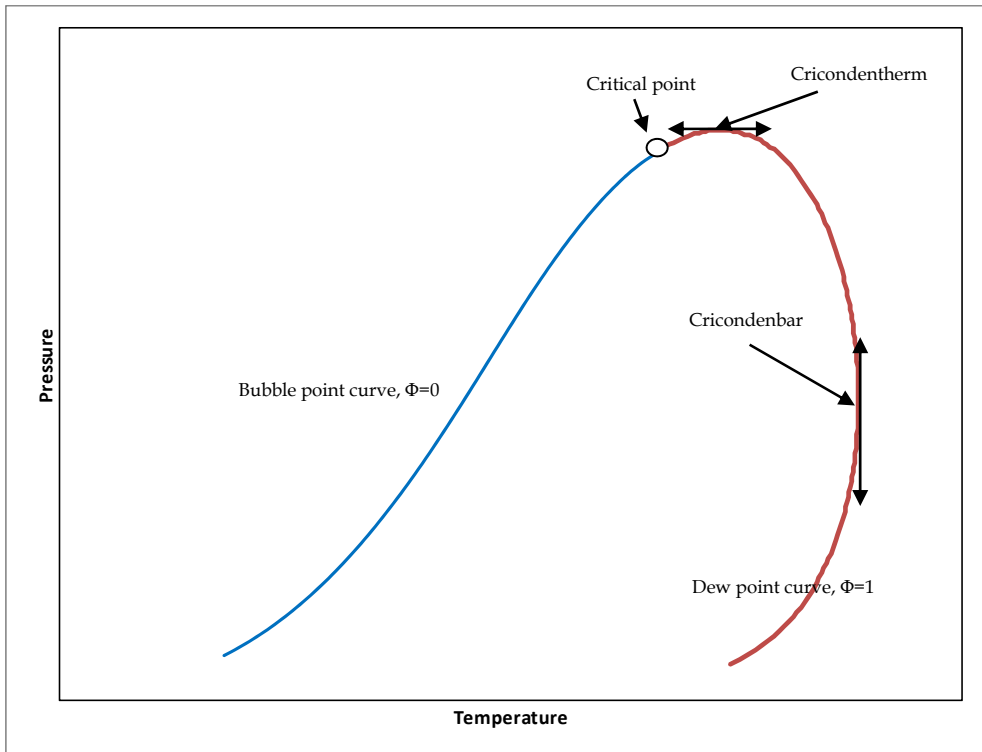

Fig. 12. Example of P-T envelop of hydrocarbons (C1 to C5).

4. Application to distillation

Distillation is the most well known separation unit operation in the world. Utilizing energy, the objective is to create one or more coexisting zones which differ in temperature, pressure, composition and phase state. In order to design a distillation column, the concept of an equilibrium stage is required: at this stage, the vapor and liquid streams which are leaving the stage are in complete equilibrium with each other and thermodynamic relations can be used to determine the temperature and the concentration of the different species for a given pressure. The equilibrium stage can be simulated as a thermodynamic isothermal FLASH (Michelsen, 1982b). Consequently, for a given distillation column, if the number of

equilibrium stages is very large it means that the separation is difficult due a relative volatility close to one. The relative volatility of component i with respect to component j is the ratio between the partition coefficient (or equilibrium constant) (Eq. 12).

$$\alpha_{ij} = \frac{K_i}{K_j} = \frac{y_i/x_i}{y_j/x_j} \quad (12)$$

In distillation, three types of binary equilibrium curves are shown in figure 13.

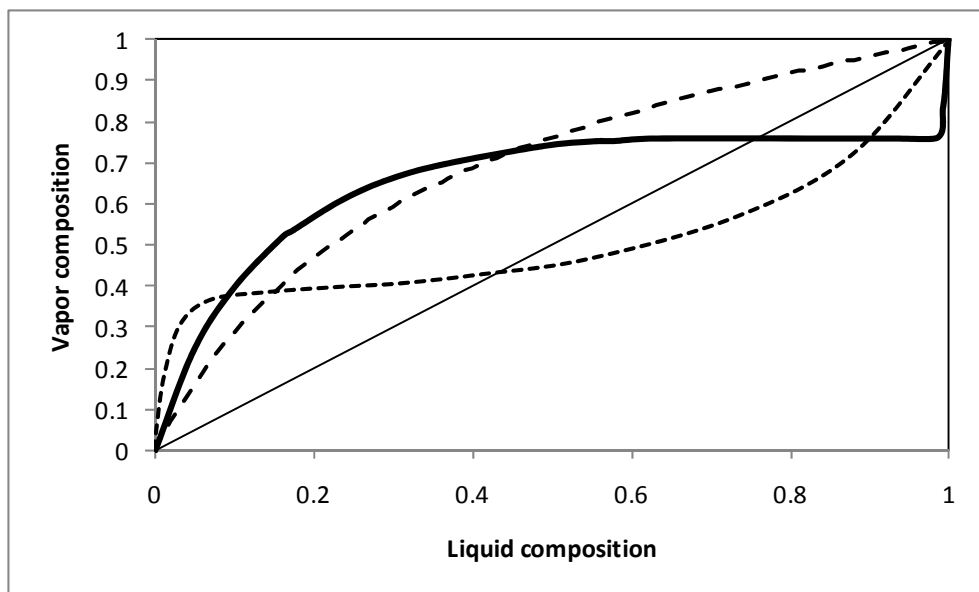

Fig. 13. Typical binary equilibrium curves. Dashed line: system with normal volatility, dotted line: system with homogenous azeotrope and solid line: system with heterogeneous azeotrope

If the relative volatility is equal to one, it is impossible to separate the two components. The phase diagrams are very important for the design of distillation columns: considering the McCabe and Thiele method (Perry & Green, 1997), the knowledge of the y - x curve together with the stream flowrates lead to the determination of the number of theoretical equilibrium stage (NTES). The McCabe-Thiele method is based on the assumption of constant molar overflow and the molar heats of vaporization of the feed components being equal; heat effects such as heats of mixing, heat transfer to and from the distillation column are negligible. If the NTES is very large, the separation is difficult. Figure 15 shows phase diagrams for an air separation unit. It can clearly be seen that the separation between O_2 and Ar is more difficult in comparison with O_2 and N_2 .

Considering a distillation column with a total reflux, the closer the values of liquid and vapor compositions, the higher is the number of equilibrium stages and more difficult is the

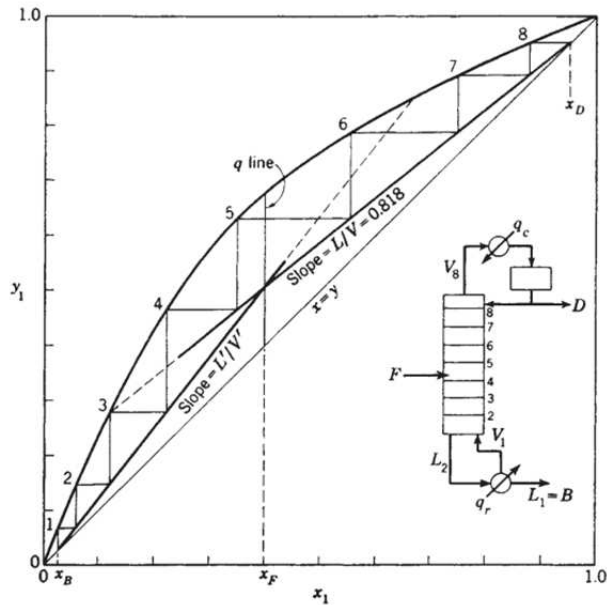

Fig. 14. Example of McCabe and Thiele construction: system Extract from Perry's handbook (Perry & Green, 1997).

phase separation. For a homogeneous azeotrope, the relative volatility is equal to one. The definition of the existence of an azeotrope is as following: $\left(\frac{\partial P}{\partial x_i}\right)_T = 0$ or $\left(\frac{\partial T}{\partial x_i}\right)_P = 0$ or $y_i = x_i$ for the N^{th} component. Moreover, considering only VLE, the mathematical criterion can determine whether there existences an azeotrope in a system which presents VLLE behavior: in this case there exists a heterogeneous azeotrope. Table 5 describes the different types or categories of azeotropes with example [12].

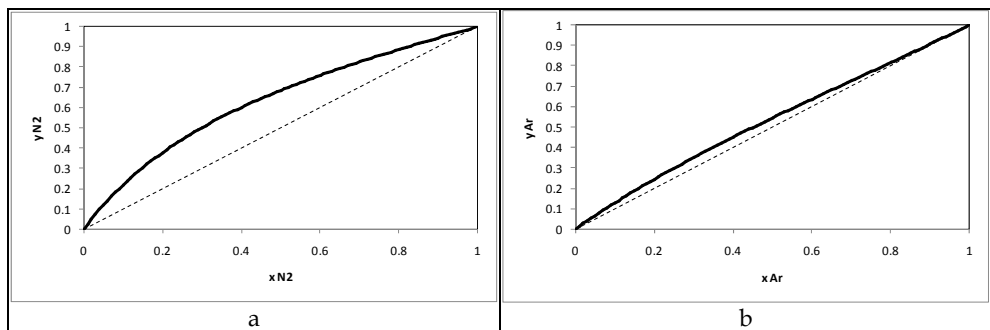

Fig. 15. Comparison between y - x phase diagram of N_2 - O_2 (a) and Ar - O_2 (b) binary systems at 110 K.

Category	Type of azeotrope	Examples
I	Homogeneous Maximum of pressure maximale	1-propanol + water ethanol + benzene
II	Heterogeneous azeotrope Maximum of pressure maximale	1-butanol + water water + benzene
III	Homogeneous Minimum of pressure	Trichloromethane + 2-butanone
IV	Homogeneous Maximum of pressure with immiscibility zone	2-butanone + water 2-butanol + water
V	Double azeotrope Local minimum and maximum of pressure	benzene + hexafluorobenzene Diethylamine + methanol
VI	Homogeneous Minimum of pressure with immiscibility zone	Triethylamine + acetic acid

Table 5. Classification of azeotropes (fixed temperature).

Figure 16 presents an example of a heterogeneous azeotropic system (2 butanol + water) at 320 K.

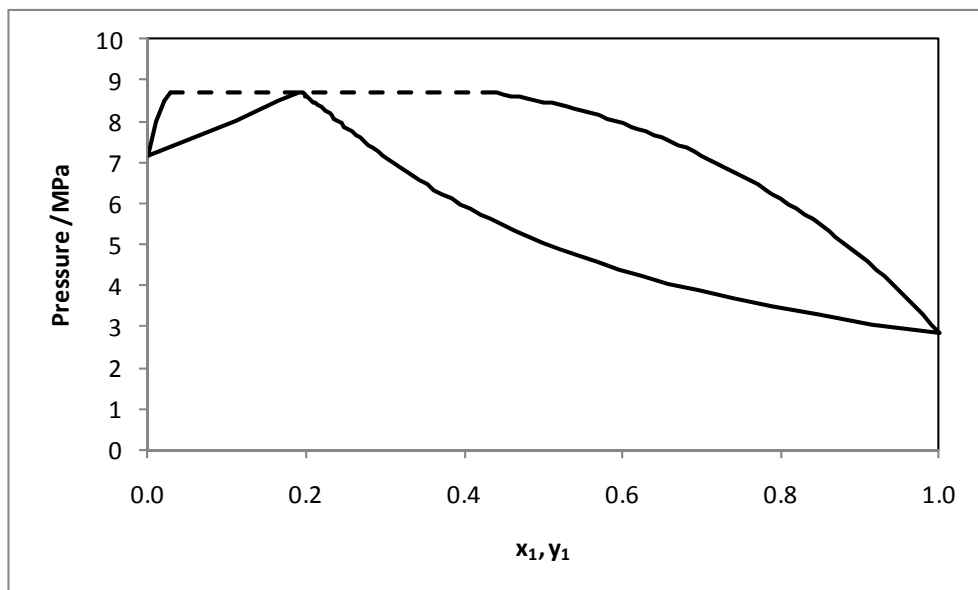

Fig. 16. 2-butanol (1) + water(2) binary system. Prediction using PSRK EoS (Holderbaum & Gmehling, 1991) at 320 K. Dashed line: Vapor Liquid Liquid equilibria (Heterogenous azeotrope)

5. Application to liquid-liquid extraction

Liquid-liquid extraction, which is commonly referred to as solvent extraction, involves the separation of the components that constitute a liquid stream by contacting it with another liquid stream which may be insoluble or partially soluble. Due to some of the components being preferentially more soluble in one of the liquid streams, separation can be effected. The separation effected in a single contacting stage is usually not large and therefore multiple contacting stages are needed to produce a significant separation. In these extraction processes the feed stream (which contains components that are to be separated) is contacted with a solvent stream. Exiting the contacting unit would be solvent-rich stream which is generally referred to as the extract and a residual liquid which is commonly called the raffinate. In general, this contacting removes a solute from the feed stream and concentrates it in the solvent-rich stream, i.e. decreasing the concentration of that particular solute in the raffinate stream.

The typical triangular diagrams which are used to illustrate ternary liquid-liquid equilibria can be converted into more convenient diagrams for visualization and computations in solvent extraction, e.g the distribution diagram, as seen in figure 17. This is undertaken because the phase relationships are generally very difficult to express conveniently algebraically and as a result solvent extraction computations are usually made graphically. The triangular diagram can also be transformed into rectangular coordinates, as seen in Figure 18.

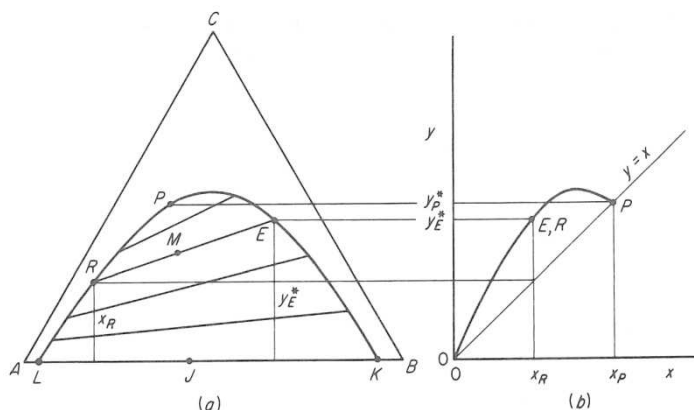

Fig. 17. Triangular (a) and distribution diagram (b) for liquid-liquid equilibria for a system of three components where one pair is partially miscible (extracted from Treybal, 1981).

The principles of separation and utilization of phase diagrams for the sizing of unit operation in solvent extraction is analogous to that which is seen in distillation, e.g. figure 18 illustrates phase diagrams being used to determine the number of theoretical stages for separation. Just as in distillation, the process can be undertaken with reflux. Reflux at the extract end can produce a product which is greater in composition, as is the case in the rectification section of a distillation column. The concept of the operating lines in the diagram, as well as the "stepping-off" in the diagram to determine the number of theoretical stages is similar to the McCabe-Thiele method for distillation.

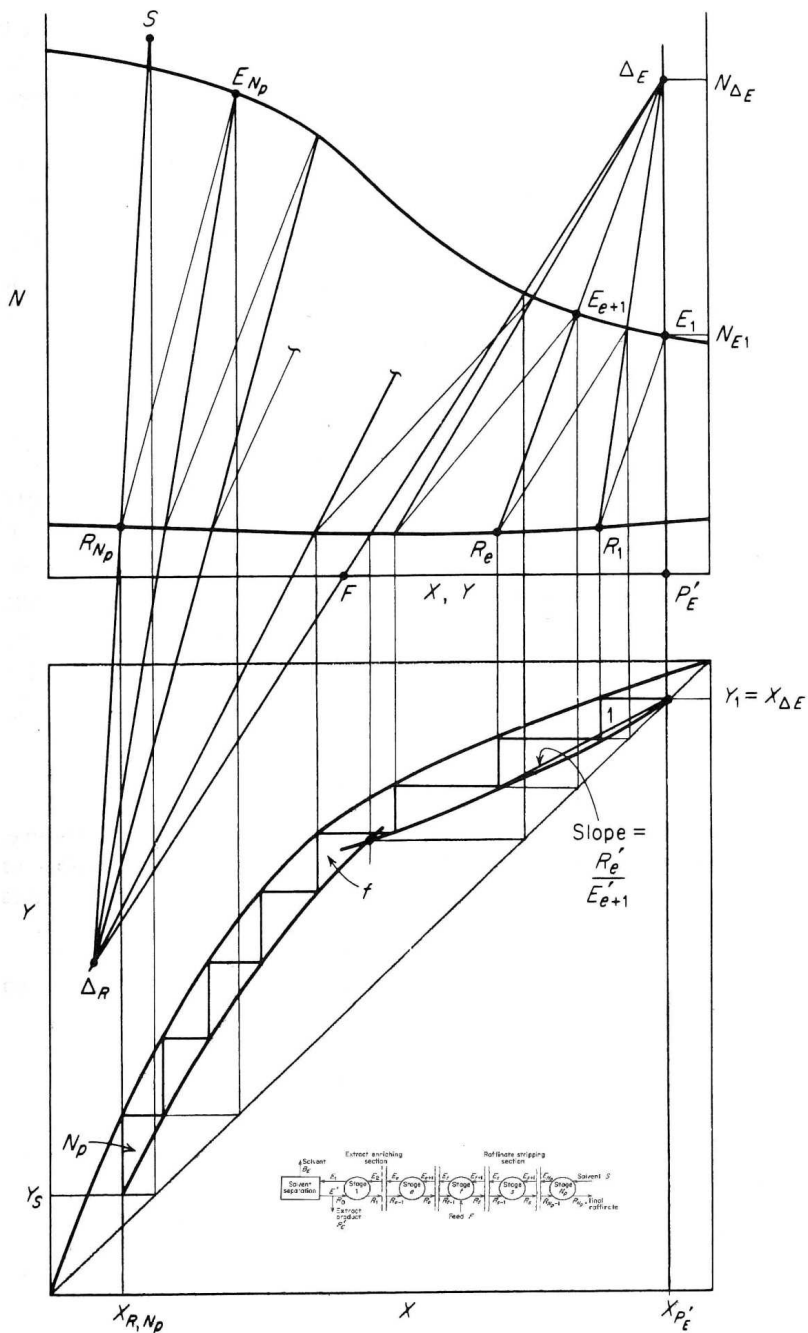

Fig. 18. Illustration of phase diagrams generated for a countercurrent extraction process with reflux (extracted from Treybal, 1981)

As the phase behaviour is affected by the choice of the solvent, and it is highly unlikely that any particular liquid will exhibit all of the properties desirable for solvent extraction, the final choice of a solvent is in most cases a compromise between various properties and parameters, viz. selectivity, distribution coefficient, insolubility of the solvent, recoverability, density, interfacial tension, chemical reactivity, viscosity, vapor pressure, freezing point, toxicity, flammability, and cost.

Generally, the key parameters (selectivity and distribution coefficient) for determining the best solvent for the separation are calculated from liquid-liquid equilibrium measurements for the system of components concerned (including the solvent).

The selectivity is defined as follows:

$$\beta = \frac{\text{wt fraction of solute in raffinate}}{\text{wt fraction of solute in extract}} \quad (13)$$

Analogous to the relative volatility in distillation, the selectivity must exceed unity (the greater the value away from unity the better) for separation to take place. If the selectivity is unity, no separation is possible. The distribution coefficient (which is effectively the inverse of selectivity) however is not required to be larger than unity, but the larger the distribution coefficient the smaller the amount of solvent which will be required for the extraction.

Excellent summaries of solvent extraction processes are given in Perry and Green (1997), as well as in Treybal (1981) and McCabe et al. (2005).

6. Conclusion

In chemical engineering, the knowledge of the phase behaviour is very important, as the design and the optimization of the separation processes needs a good knowledge of the phase diagrams. Practically, the determination of phase diagrams can be obtained through experimental methods and/or modelling. The readers can refer to the books of Raal and Mühlauber (1998) to have a complete description of experimental methods, and Prausnitz et al. (1999) regarding models and principles. The complexity of phase diagrams is increased drastically if a solid or a polymer phase exists, however the purpose of this chapter was to introduce the reader to phase diagrams encountered by chemical engineers in the most commonly used units operations, viz. distillation and solvent extraction.

7. References

- Baker, L.E., Pierce, A.C., Luks, K.D. (1982) Gibbs Energy Analysis of Phase Equilibria, *Society of Petroleum Engineers Journal*, October, pp 731-742, ISSN: 0197-7520
- Coquelet, C., Chareton, A., Richon, D. (2004) Vapour-liquid equilibrium measurements and correlation of the difluoromethane (R32) + propane (R290) + 1,1,1,2,3,3,3-heptafluoropropane (R227ea) ternary mixture at temperatures from 269.85 to 328.35 K. *Fluid Phase Equilibria*, Vol. 218, pp 209-214, ISSN 0378-3812
- Gmehling, J., Menke, J., Krafczyk, J., Fischer, K. (1994) *Azeotropic Data Part I*, Wiley-VCH, ISBN : 3-527-28671-3, Weinheim, Germany.

- Heidemann, R. A. & Khalil, A. M. (1980) The Calculation of Critical Points, *American Institute of Chemical Engineers Journal*, Vol. 26, No.5, pp 769-779, ISSN (printed): 0001-1541. ISSN (electronic): 1547-5905
- Holderbaum, T. & Gmehling, J. (1991) PSRK : A group contribution equation of state based on UNIFAC, *Fluid Phase Equilibria*, Vol. 70, pp 251-265, ISSN 0378-3812
- McCabe, W., Smith J., Harriot, P. (2005) *Unit Operations of Chemical Engineering* 7th edition, McGraw-Hill Book Company, ISBN 0072848235.
- Michelsen, M. L. (1980) Calculation of phase envelopes and critical point for multicomponent mixtures, *Fluid Phase Equilibria*, Vol. 4, pp 1-10, ISSN 0378-3812
- Michelsen, M. L. (1982a) The isothermal Flash Problem. Part I Stability. *Fluid Phase Equilibria*, Vol. 9, pp 1-19, ISSN 0378-3812
- Michelsen, M. L. (1982b) The isothermal Flash Problem. Part II Phase Split Calculation, *Fluid Phase Equilibria*, Vol. 9, pp 21-40, ISSN 0378-3812
- Perry, R.H. & Green, D.W. (1997) *Perry's chemical Handbook* 7th , edition McGraw Hill Companies, ISBN0-07-049841-5, New York, USA
- Prausnitz, J.M., Lichtenthaler R.N., de Azevedo, E. G. (1999) *Molecular thermodynamics of fluid phase equilibria*, 3rd edition, Prentice Hall International Series, Upper Saddle River, USA.
- Raal, J. D. & Mühlbauer A. L. (1997) *Phase Equilibria, Measurement and Computation*, Taylor & Francis, ISBN 1-56032-550-X, London, UK.
- Stockfleth, R. & Dohrn, R. (1998) An algorithm for calculating critical points in multicomponent mixtures which can be easily implemented in existing programs to calculate phase equilibria. *Fluid Phase Equilibria*, Vol. 145, pp 43-52, ISSN 0378-3812
- Treybal, R.E. (1981) *Mass-Transfer Operations* 3rd edition, McGraw-Hill Book Company, ISBN-0-07-065176-0, Singapore.
- Van der Waals, J.D. (1899) *Over de Continuïteit van den Gas- en Vloestoftoestand. (Über die Kontinuität des Gas- und Flüssigkeitszustands)* 1873, Dissertation, Universität Leiden, Niederlande, deutsche Übersetzung, Leipzig, Germany.
- Van Konynenburg, P. H. & Scott, R.L. (1980) Critical lines and Phase Equilibria in Binary van der Waals mixtures. *Philosophical Transactions of the Royal Society of London*, Vol. 298, pp 495-539, ISSN 0264-3820
- Weintsock, J. J. (1952) *Phase equilibrium at elevated pressure in ternary systems of ethylene and water and organic liquids*, Phd dissertation, Princeton University, USA